

Year 1 - 6

Calculation Policy

Addition and Subtraction

[#MathsEveryoneCan](#)



Calculation Policy

Welcome to the White Rose Maths Calculation Policy.

This document is broken down into addition and subtraction, and multiplication and division.

At the start of each policy, there is an overview of the different models and images that can support the teaching of different concepts. These provide explanations of the benefits of using the models and show the links between different operations.

Each operation is then broken down into skills and each skill has a dedicated page showing the different models and images that could be used to effectively teach that concept.

Ten Frames (within 20)

$8 + 7 = 15$

$14 - 6 = 8$

$7 + 6 + 3 = 16$

Benefits

When adding two single digits, children can make each number on separate ten frames before moving part of one number to make 10 on one of the ten frames. This supports children to see how they have partitioned one of the numbers to make 10, and makes links to effective mental methods of addition.

When subtracting a one-digit number from a two-digit number, firstly make the larger number on 2 ten frames. Remove the smaller number, thinking carefully about how you have partitioned the number to make 10, this supports mental methods of subtraction.

When adding three single-digit numbers, children can make each number on 3 separate 10 frames before considering which order to add the numbers in. They may be able to find a number bond to 10 which makes the calculation easier. Once again, the ten frames support the link to effective mental methods of addition as well as the importance of commutativity.

Skill: Add 1 and 2-digit numbers to 20

$8 + 7 = 15$

Year: 1/2

When adding one-digit numbers that cross 10, it is important to highlight the importance of ten ones equalling one ten.

Different manipulatives can be used to represent this exchange. Use concrete resources alongside number lines to support children in understanding how to partition their jumps.

There is an overview of skills linked to year groups to support consistency through out school. A glossary of terms is provided at the end of the calculation policy to support understanding of the key language used to teach the four operations.

Part-Whole Model

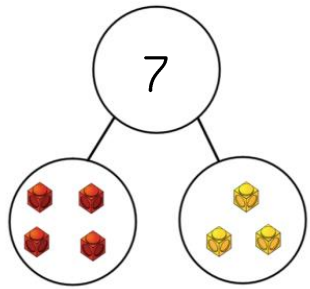

$$7 = 4 + 3$$

$$7 = 3 + 4$$

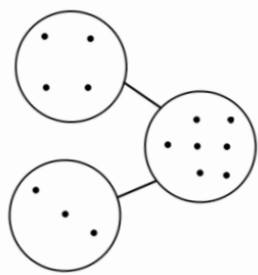

$$7 - 3 = 4$$

$$7 - 4 = 3$$

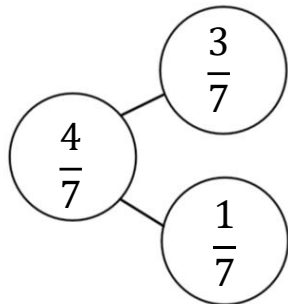
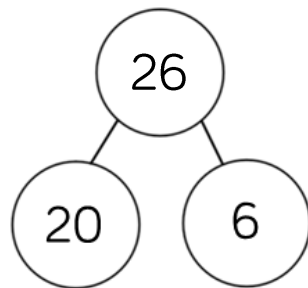
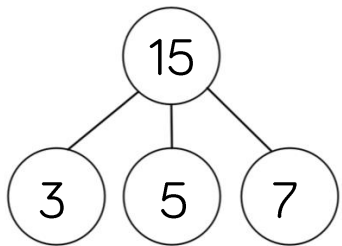
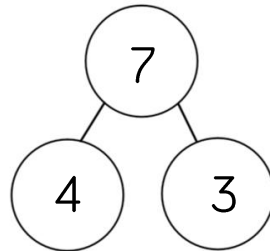

Benefits

This part-whole model supports children in their understanding of aggregation and partitioning. Due to its shape, it can be referred to as a cherry part-whole model.

When the parts are complete and the whole is empty, children use aggregation to add the parts together to find the total.

When the whole is complete and at least one of the parts is empty, children use partitioning (a form of subtraction) to find the missing part.

Part-whole models can be used to partition a number into two or more parts, or to help children to partition a number into tens and ones or other place value columns.

In KS2, children can apply their understanding of the part-whole model to add and subtract fractions, decimals and percentages.

Bar Model (single)

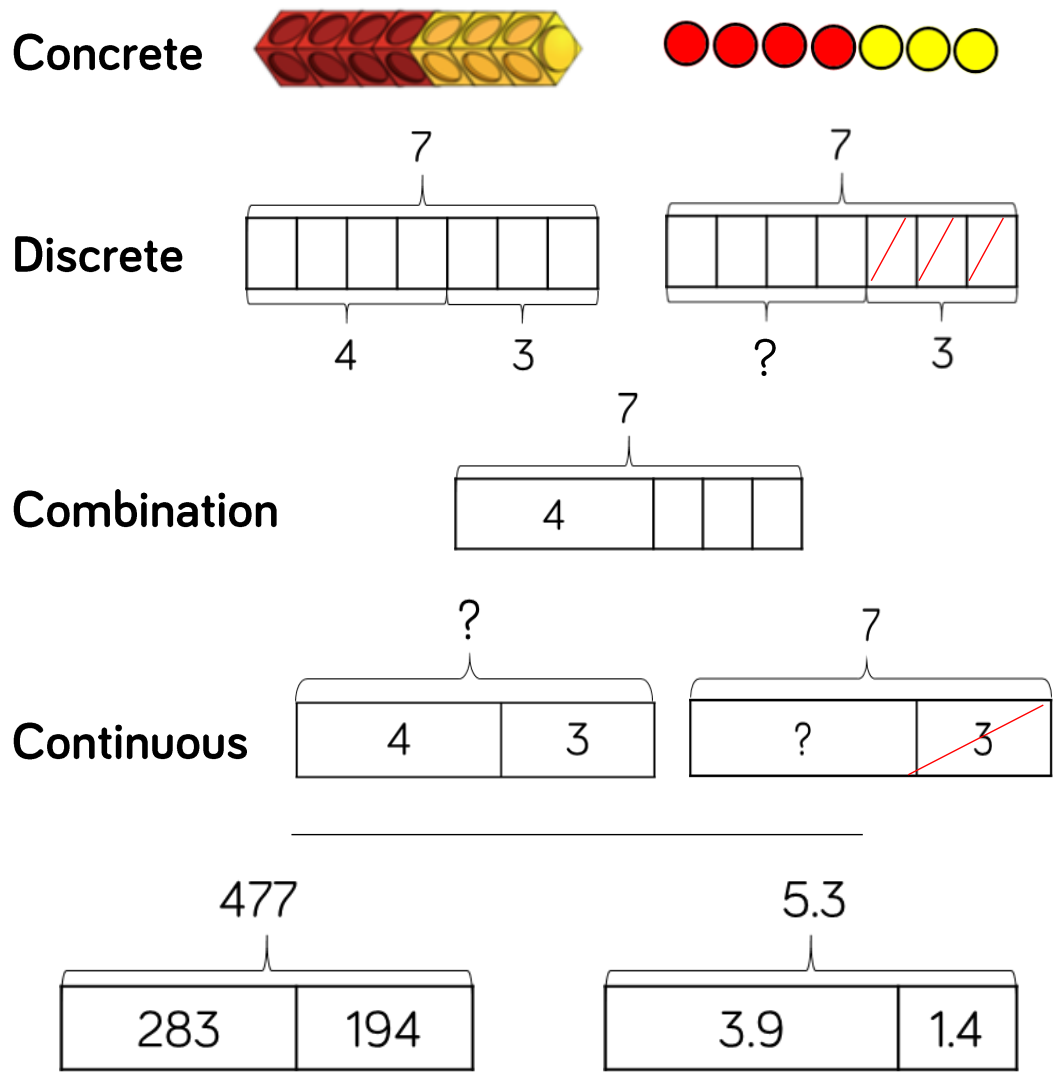

Benefits

The single bar model is another type of a part-whole model that can support children in representing calculations to help them unpick the structure.

Cubes and counters can be used in a line as a concrete representation of the bar model.

Discrete bar models are a good starting point with smaller numbers. Each box represents one whole.

The combination bar model can support children to calculate by counting on from the larger number. It is a good stepping stone towards the continuous bar model.

Continuous bar models are useful for a range of values. Each rectangle represents a number. The question mark indicates the value to be found.

In KS2, children can use bar models to represent larger numbers, decimals and fractions.

Bar Model (multiple)

Discrete

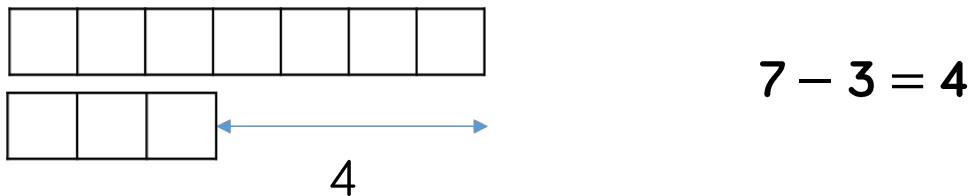
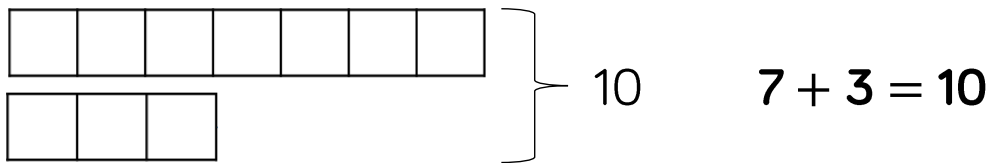

Continuous

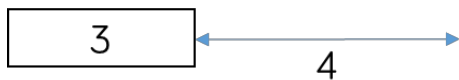
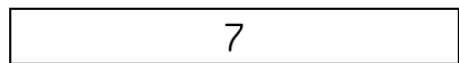

$$7 - 3 = 4$$

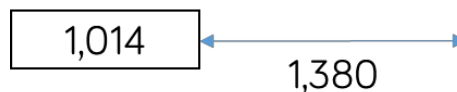
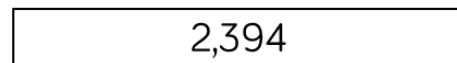

$$2,394 - 1,014 = 1,380$$

Benefits

The multiple bar model is a good way to compare quantities whilst still unpicking the structure.

Two or more bars can be drawn, with a bracket labelling the whole positioned on the right hand side of the bars. Smaller numbers can be represented with a discrete bar model whilst continuous bar models are more effective for larger numbers.

Multiple bar models can also be used to represent the difference in subtraction. An arrow can be used to model the difference.

When working with smaller numbers, children can use cubes and a discrete model to find the difference. This supports children to see how counting on can help when finding the difference.

Number Shapes



$$7 = 4 + 3$$



$$7 = 3 + 4$$

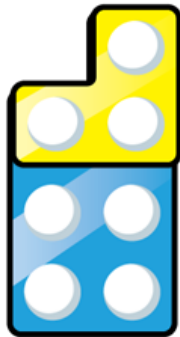

$$7 - 3 = 4$$

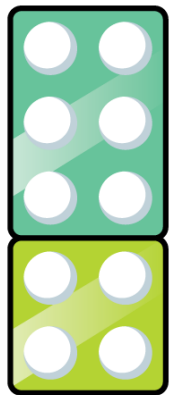

$$6 + 4$$

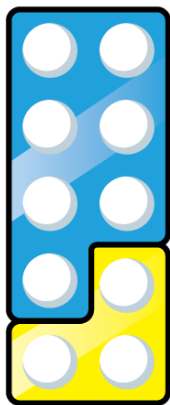

$$7 + 3$$

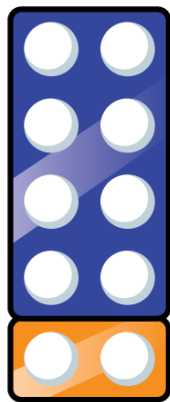

$$8 + 2$$

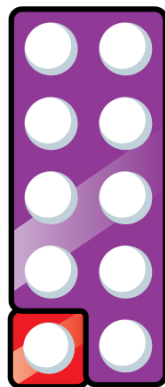

$$9 + 1$$

Benefits

Number shapes can be useful to support children to subitise numbers as well as explore aggregation, partitioning and number bonds.

When adding numbers, children can see how the parts come together making a whole. As children use number shapes more often, they can start to subitise the total due to their familiarity with the shape of each number.

When subtracting numbers, children can start with the whole and then place one of the parts on top of the whole to see what part is missing. Again, children will start to be able to subitise the part that is missing due to their familiarity with the shapes.

Children can also work systematically to find number bonds. As they increase one number by 1, they can see that the other number decreases by 1 to find all the possible number bonds for a number.

Cubes

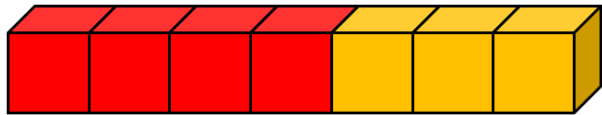

$$7 = 4 + 3$$

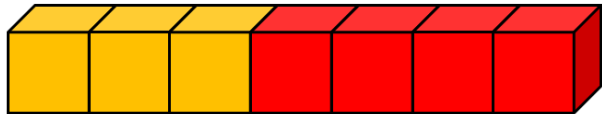

$$7 = 3 + 4$$

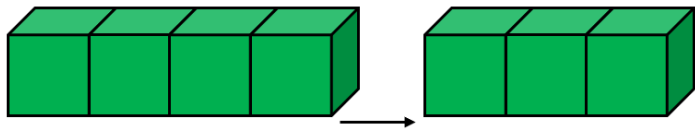

$$7 - 3 = 4$$

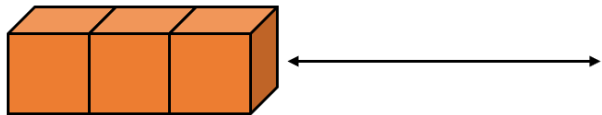
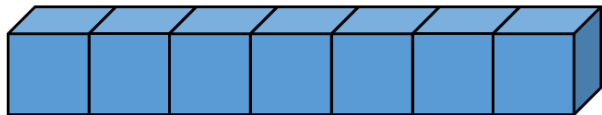

$$7 - 3 = 4$$

Benefits

Cubes can be useful to support children with the addition and subtraction of one-digit numbers.

When adding numbers, children can see how the parts come together to make a whole. Children could use two different colours of cubes to represent the numbers before putting them together to create the whole.

When subtracting numbers, children can start with the whole and then remove the number of cubes that they are subtracting in order to find the answer. This model of subtraction is reduction, or take away.

Cubes can also be useful to look at subtraction as difference. Here, both numbers are made and then lined up to find the difference between the numbers.

Cubes are useful when working with smaller numbers but are less efficient with larger numbers as they are difficult to subitise and children may miscount them.

Ten Frames (within 10)

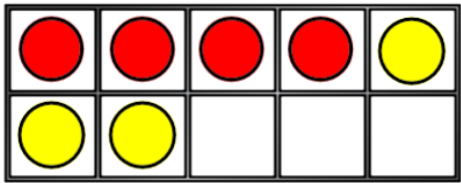

$$4 + 3 = 7$$

$$3 + 4 = 7$$

$$7 - 3 = 4$$

$$7 - 4 = 3$$

4 is a part.

3 is a part.

7 is the whole.

First

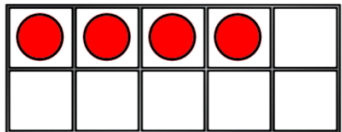

Then

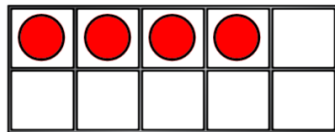

$$4 + 3 = 7$$

Now

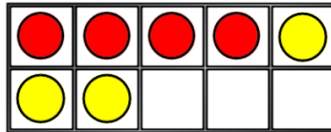

First

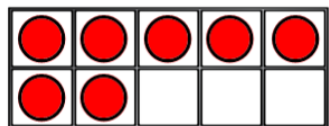

Then

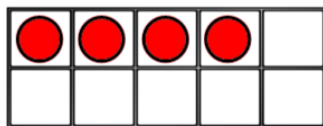

$$7 - 3 = 4$$

Now

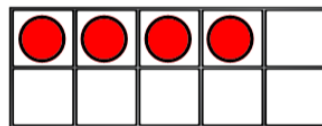

Benefits

When adding and subtracting within 10, the ten frame can support children to understand the different structures of addition and subtraction.

Using the language of parts and wholes represented by objects on the ten frame introduces children to aggregation and partitioning.

Aggregation is a form of addition where parts are combined together to make a whole. Partitioning is a form of subtraction where the whole is split into parts. Using these structures, the ten frame can enable children to find all the number bonds for a number.

Children can also use ten frames to look at augmentation (increasing a number) and take-away (decreasing a number). This can be introduced through a first, then, now structure which shows the change in the number in the 'then' stage. This can be put into a story structure to help children understand the change e.g. First, there were 7 cars. Then, 3 cars left. Now, there are 4 cars.

Ten Frames (within 20)

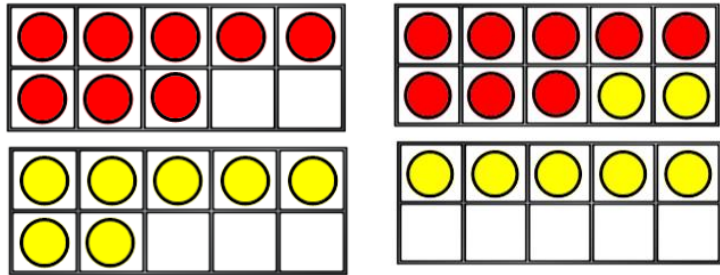

$$8 + 7 = 15$$

Diagram showing 8 partitioned into 2 and 5. A blue oval encircles the 8 and the 2.

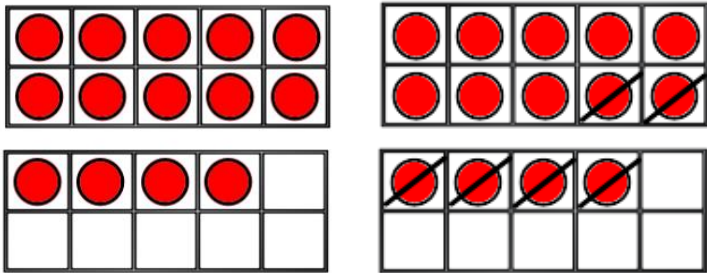

$$14 - 6 = 8$$

Diagram showing 14 partitioned into 4 and 2. A blue oval encircles the 14 and the 4.

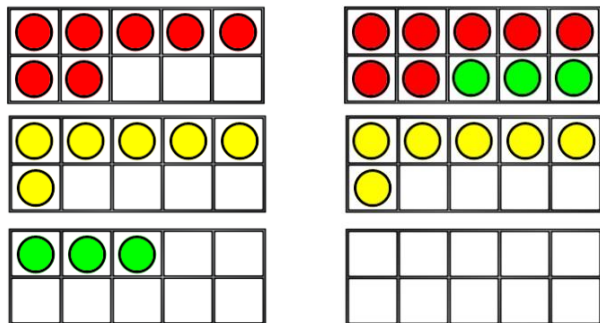

$$7 + 6 + 3 = 16$$

Diagram showing 10 below the equation with lines connecting it to the 7 and 3.

Benefits

When adding two single digits, children can make each number on separate ten frames before moving part of one number to make 10 on one of the ten frames. This supports children to see how they have partitioned one of the numbers to make 10, and makes links to effective mental methods of addition.

When subtracting a one-digit number from a two-digit number, firstly make the larger number on 2 ten frames. Remove the smaller number, thinking carefully about how you have partitioned the number to make 10, this supports mental methods of subtraction.

When adding three single-digit numbers, children can make each number on 3 separate 10 frames before considering which order to add the numbers in. They may be able to find a number bond to 10 which makes the calculation easier. Once again, the ten frames support the link to effective mental methods of addition as well as the importance of commutativity.

Bead Strings

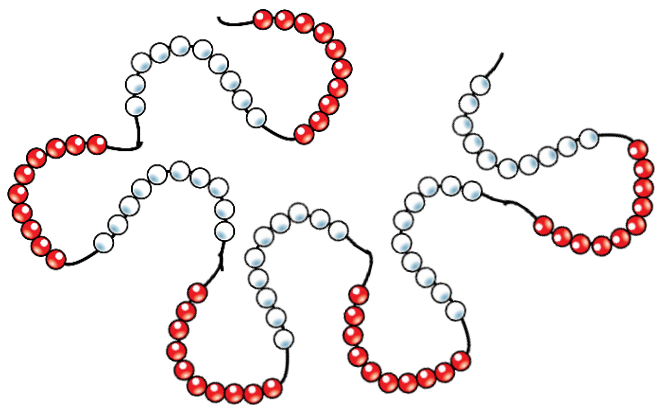
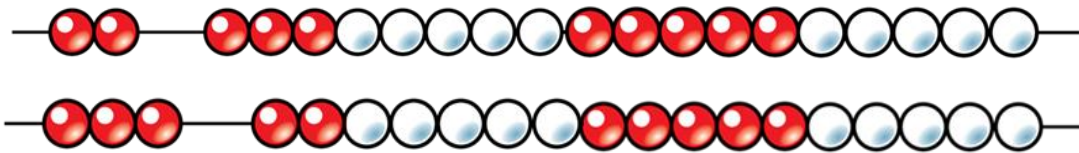
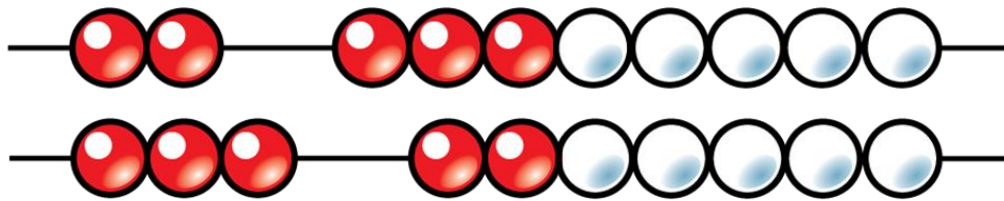

Benefits

Different sizes of bead strings can support children at different stages of addition and subtraction.

Bead strings to 10 are very effective at helping children to investigate number bonds up to 10.

They can help children to systematically find all the number bonds to 10 by moving one bead at a time to see the different numbers they have partitioned the 10 beads into e.g. $2 + 8 = 10$, move one bead, $3 + 7 = 10$.

Bead strings to 20 work in a similar way but they also group the beads in fives. Children can apply their knowledge of number bonds to 10 and see the links to number bonds to 20.

Bead strings to 100 are grouped in tens and can support children in number bonds to 100 as well as helping when adding by making ten. Bead strings can show a link to adding to the next 10 on number lines which supports a mental method of addition.

Number Tracks

$$5 + 3 = 8$$

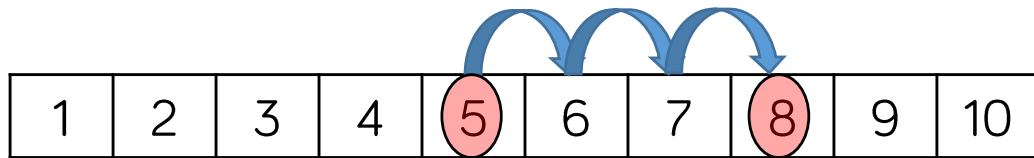

$$10 - 4 = 6$$

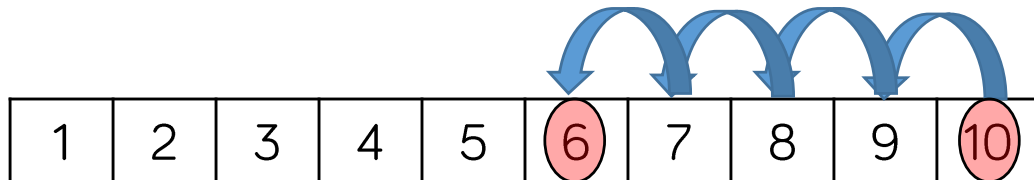

$$8 + 7 = 15$$

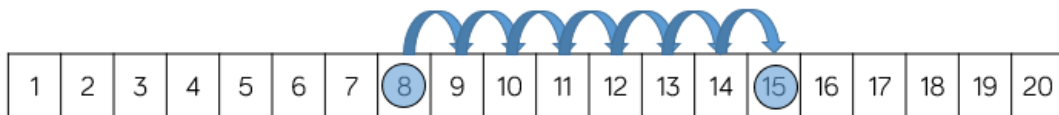

Benefits

Number tracks are useful to support children in their understanding of augmentation and reduction.

When adding, children count on to find the total of the numbers. On a number track, children can place a counter on the starting number and then count on to find the total.

When subtracting, children count back to find their answer. They start at the minuend and then take away the subtrahend to find the difference between the numbers.

Number tracks can work well alongside ten frames and bead strings which can also model counting on or counting back.

Playing board games can help children to become familiar with the idea of counting on using a number track before they move on to number lines.

Number Lines (labelled)

$$5 + 3 = 8$$

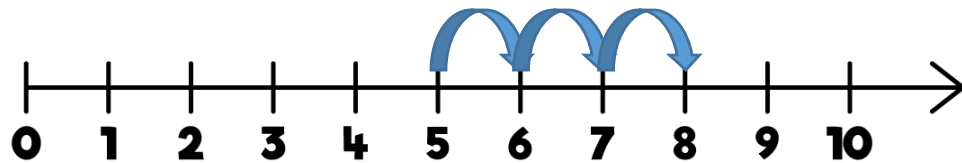

$$8 + 7 = 15$$

The number 8 is circled in blue. A line connects 8 to 2, and another line connects 8 to 5.

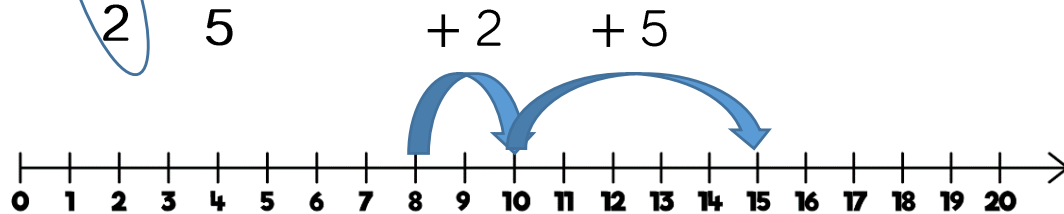

$$14 - 6 = 8$$

The number 14 is circled in blue. A line connects 14 to 4, and another line connects 14 to 2.

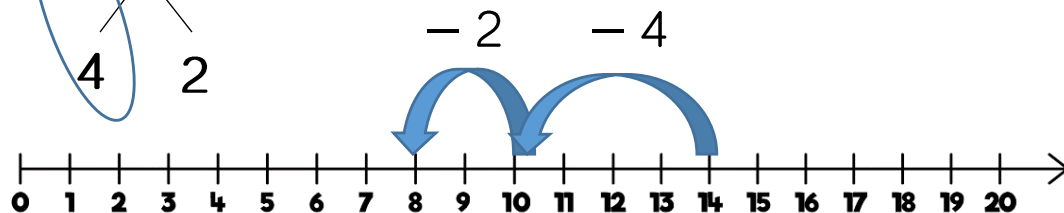

Benefits

Labelled number lines support children in their understanding of addition and subtraction as augmentation and reduction.

Children can start by counting on or back in ones, up or down the number line. This skill links directly to the use of the number track.

Progressing further, children can add numbers by jumping to the nearest 10 and then jumping to the total. This links to the making 10 method which can also be supported by ten frames. The smaller number is partitioned to support children to make a number bond to 10 and to then add on the remaining part.

Children can subtract numbers by firstly jumping to the nearest 10. Again, this can be supported by ten frames so children can see how they partition the smaller number into the two separate jumps.

Number Lines (blank)

$$35 + 37 = 72$$

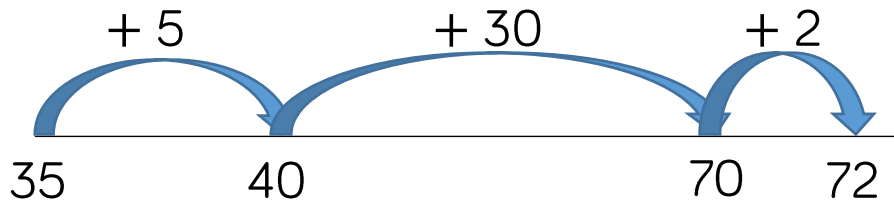

$$35 + 37 = 72$$

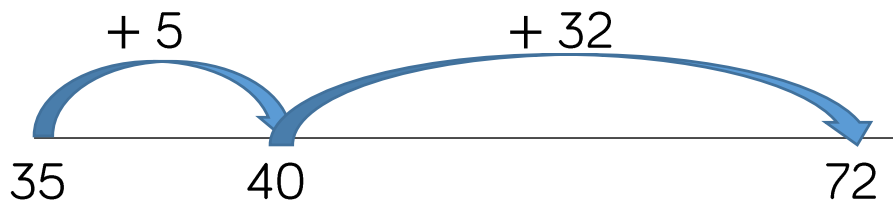

$$72 - 35 = 37$$

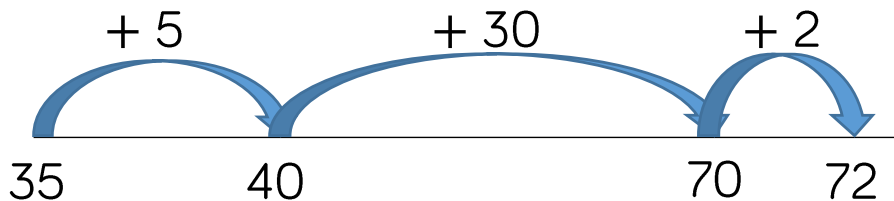

Benefits

Blank number lines provide children with a structure to add and subtract numbers in smaller parts.

Developing from labelled number lines, children can add by jumping to the nearest 10 and then adding the rest of the number either as a whole or by adding the tens and ones separately.

Children may also count back on a number line to subtract, again by jumping to the nearest 10 and then subtracting the rest of the number.

Blank number lines can also be used effectively to help children subtract by finding the difference between numbers. This can be done by starting with the smaller number and then counting on to the larger number. They then add up the parts they have counted on to find the difference between the numbers.

Straws

$$7 + 6 = 13$$

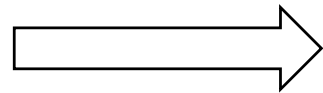
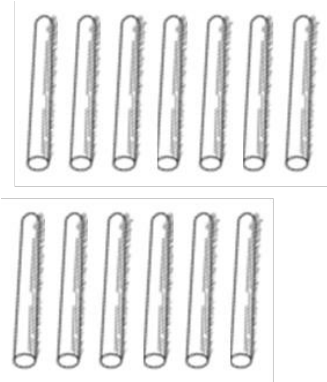

bundle together
groups of 10

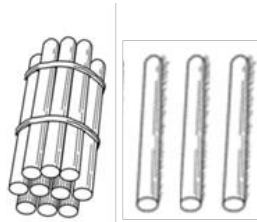

$$42 - 17 = 25$$

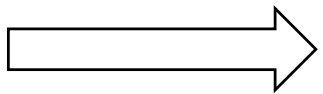
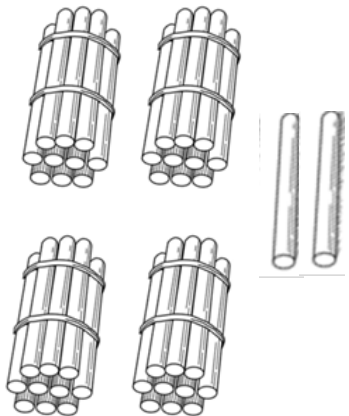

unbundle group
of 10 straws

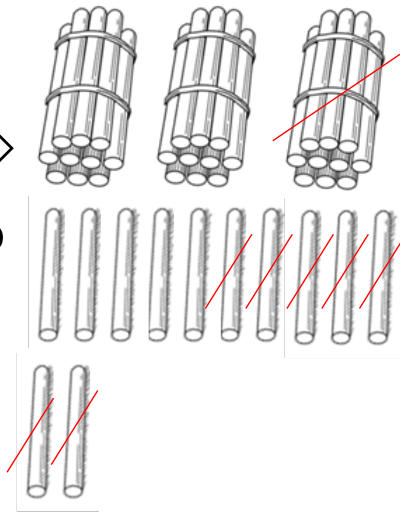

Benefits

Straws are an effective way to support children in their understanding of exchange when adding and subtracting 2-digit numbers.

Children can be introduced to the idea of bundling groups of ten when adding smaller numbers and when representing 2-digit numbers. Use elastic bands or other ties to make bundles of ten straws.

When adding numbers, children bundle a group of 10 straws to represent the exchange from 10 ones to 1 ten. They then add the individual straws (ones) and bundles of straws (tens) to find the total.

When subtracting numbers, children unbundle a group of 10 straws to represent the exchange from 1 ten to 10 ones.

Straws provide a good stepping stone to adding and subtracting with Base 10/Dienes.

Base 10/Dienes (addition)

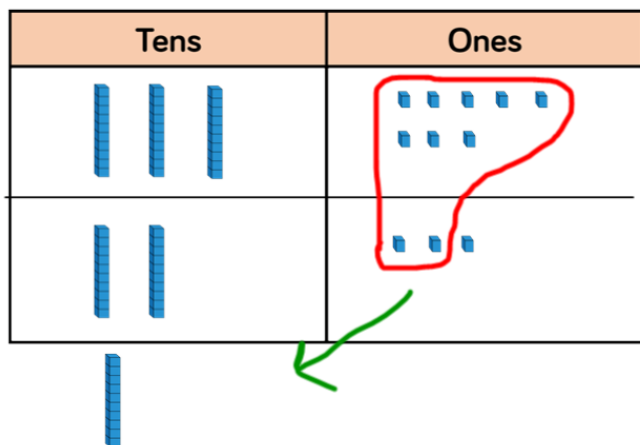

$$\begin{array}{r} 38 \\ + 23 \\ \hline 61 \\ \hline 1 \end{array}$$

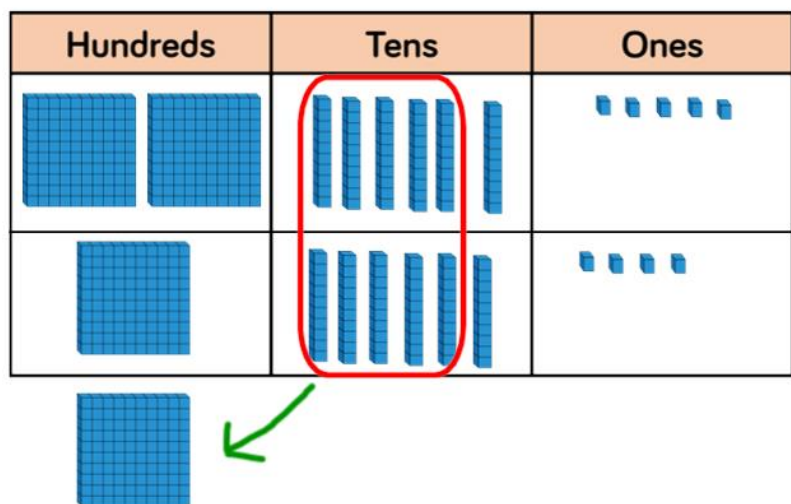

$$\begin{array}{r} 265 \\ + 164 \\ \hline 429 \\ \hline 1 \end{array}$$

Benefits

Using Base 10 or Dienes is an effective way to support children's understanding of column addition. It is important that children write out their calculations alongside using or drawing Base 10 so they can see the clear links between the written method and the model.

Children should first add without an exchange before moving on to addition with exchange. The representation becomes less efficient with larger numbers due to the size of Base 10. In this case, place value counters may be the better model to use.

When adding, always start with the smallest place value column. Here are some questions to support children.

How many ones are there altogether?

Can we make an exchange? (Yes or No)

How many do we exchange? (10 ones for 1 ten, show exchanged 10 in tens column by writing 1 in column)

How many ones do we have left? (Write in ones column)

Repeat for each column.

Base 10/Dienes (subtraction)

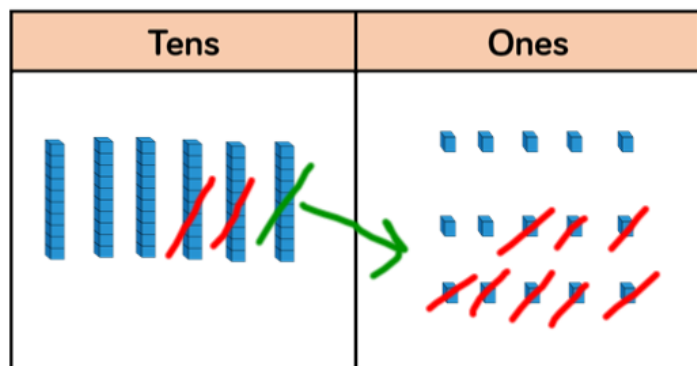

$$\begin{array}{r}
 \overset{5}{\cancel{6}} \overset{1}{5} \\
 - 28 \\
 \hline
 37
 \end{array}$$

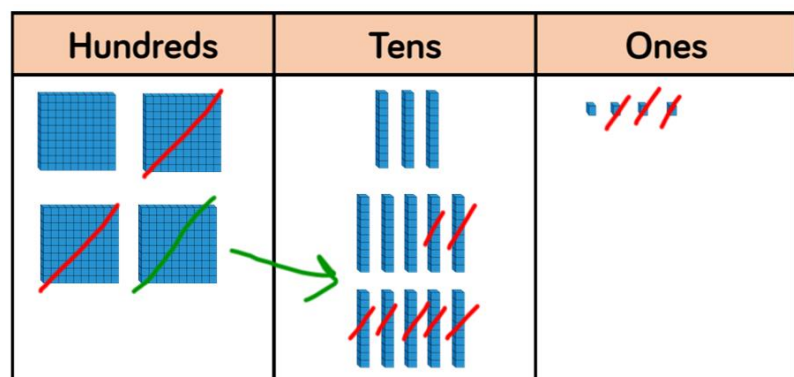

$$\begin{array}{r}
 \overset{3}{\cancel{4}} \overset{1}{3} \overset{1}{5} \\
 - 273 \\
 \hline
 262
 \end{array}$$

Benefits

Using Base 10 or Dienes is an effective way to support children's understanding of column subtraction. It is important that children write out their calculations alongside using or drawing Base 10 so they can see the clear links between the written method and the model.

Children should first subtract without an exchange before moving on to subtraction with exchange. When building the model, children should just make the minuend using Base 10, they then subtract the subtrahend. Highlight this difference to addition to avoid errors by making both numbers. Children start with the smallest place value column. When there are not enough ones/tens/hundreds to subtract in a column, children need to move to the column to the left and exchange e.g. exchange 1 ten for 10 ones. They can then subtract efficiently.

This model is efficient with up to 4-digit numbers. Place value counters are more efficient with larger numbers and decimals.

Place Value Counters (addition)

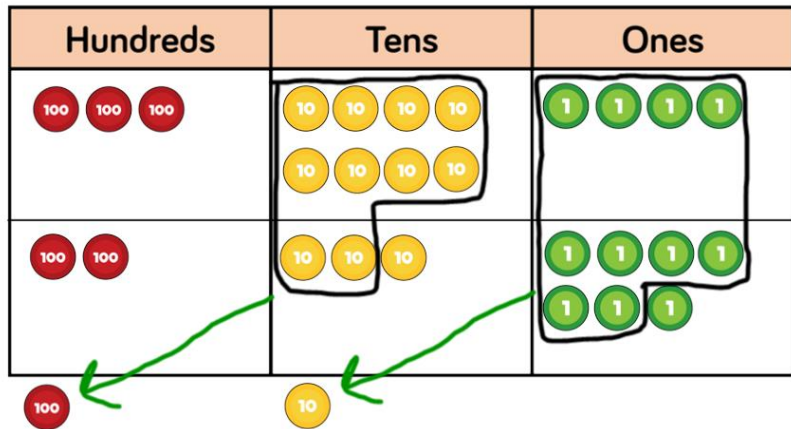

$$\begin{array}{r} 384 \\ + 237 \\ \hline 621 \\ 1 \quad 1 \end{array}$$

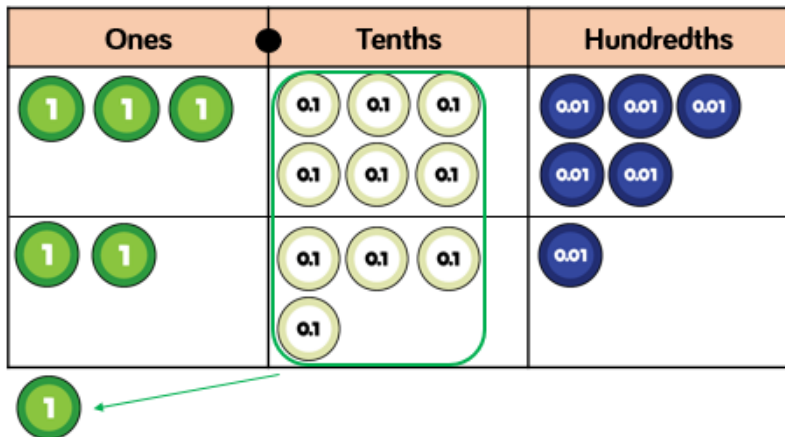

$$\begin{array}{r} 3.65 \\ + 2.41 \\ \hline 6.06 \\ 1 \end{array}$$

Benefits

Using place value counters is an effective way to support children's understanding of column addition. It is important that children write out their calculations alongside using or drawing counters so they can see the clear links between the written method and the model.

Children should first add without an exchange before moving on to addition with exchange. Different place value counters can be used to represent larger numbers or decimals. If you don't have place value counters, use normal counters on a place value grid to enable children to experience the exchange between columns.

When adding money, children can also use coins to support their understanding. It is important that children consider how the coins link to the written calculation especially when adding decimal amounts.

Place Value Counters (Subtraction)

Hundreds	Tens	Ones

$$\begin{array}{r}
 \overset{4}{\cancel{6}}\overset{1}{\cancel{5}}2 \\
 - 207 \\
 \hline
 445
 \end{array}$$

Thousands	Hundreds	Tens	Ones

$$\begin{array}{r}
 \overset{3}{\cancel{4}}\overset{1}{\cancel{3}}57 \\
 - 2735 \\
 \hline
 1622
 \end{array}$$

Benefits

Using place value counters is an effective way to support children's understanding of column subtraction. It is important that children write out their calculations alongside using or drawing counters so they can see the clear links between the written method and the model.

Children should first subtract without an exchange before moving on to subtraction with exchange. If you don't have place value counters, use normal counters on a place value grid to enable children to experience the exchange between columns.

When building the model, children should just make the minuend using counters, they then subtract the subtrahend. Children start with the smallest place value column. When there are not enough ones/tens/hundreds to subtract in a column, children need to move to the column to the left and exchange e.g. exchange 1 ten for 10 ones. They can then subtract efficiently.

Addition

Skill	Year	Representations and models	
Add two 1-digit numbers to 10	1	Part-whole model Bar model Number shapes	Ten frames (within 10) Bead strings (10) Number tracks
Add 1 and 2-digit numbers to 20	1	Part-whole model Bar model Number shapes Ten frames (within 20)	Bead strings (20) Number tracks Number lines (labelled) Straws
Add three 1-digit numbers	2	Part-whole model Bar model	Ten frames (within 20) Number shapes
Add 1 and 2-digit numbers to 100	2	Part-whole model Bar model Number lines (labelled)	Number lines (blank) Straws Hundred square

Skill	Year	Representations and models
Add two 2-digit numbers	2	Part-whole model Bar model Number lines (blank) Straws Base 10 Place value counters Column addition
Add with up to 3-digits	3	Part-whole model Bar model Base 10 Place value counters Column addition
Add with up to 4-digits	4	Part-whole model Bar model Base 10 Place value counters Column addition
Add with more than 4 digits	5	Part-whole model Bar model Place value counters Column addition
Add with up to 3 decimal places	5	Part-whole model Bar model Place value counters Column addition

Skill: Add 1-digit numbers within 10

Year: 1

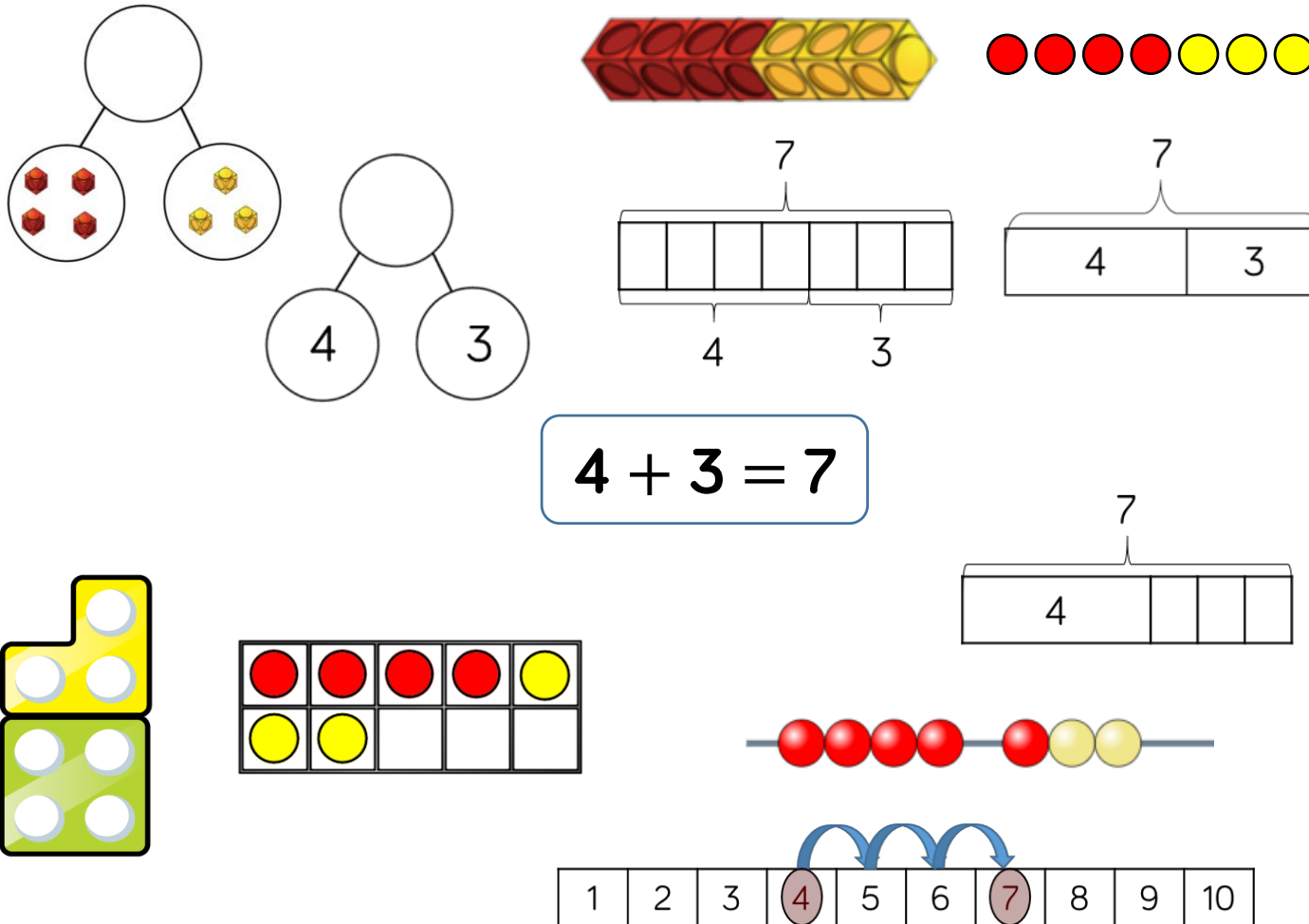

When adding numbers to 10, children can explore both aggregation and augmentation.

The part-whole model, discrete and continuous bar model, number shapes and ten frame support aggregation.

The combination bar model, ten frame, bead string and number track all support augmentation.

Skill: Add 1 and 2-digit numbers to 20

Year: 1/2

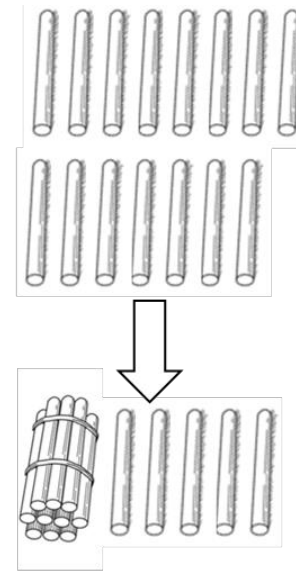
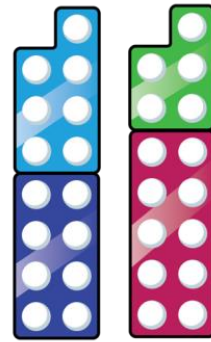
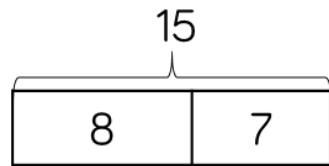
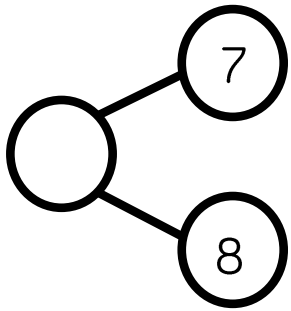

$$8 + 7 = 15$$

$$8 + 7 = 15$$

2 5

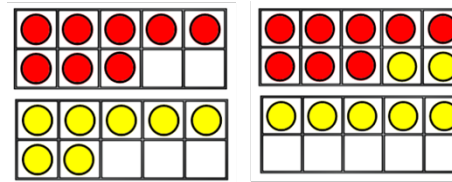
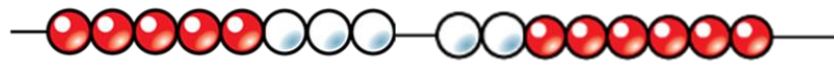
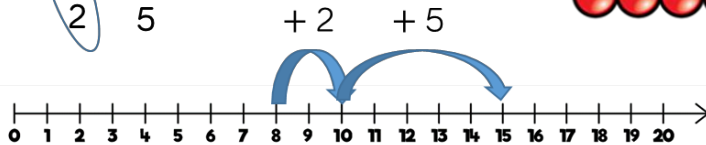

$$8 + 7 = 15$$

2 5

When adding one-digit numbers that cross 10, it is important to highlight the importance of ten ones equalling one ten.

Different manipulatives can be used to represent this exchange. Use concrete resources alongside number lines to support children in understanding how to partition their jumps.

Skill: Add three 1-digit numbers

Year: 2

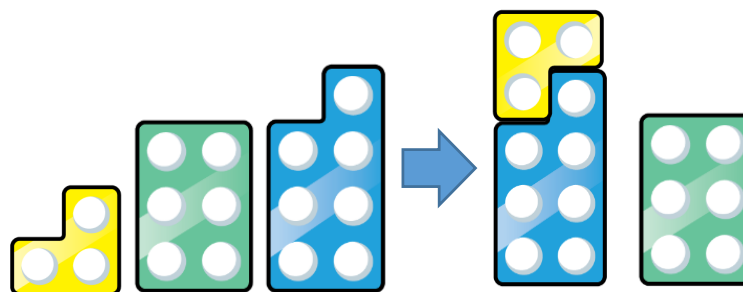
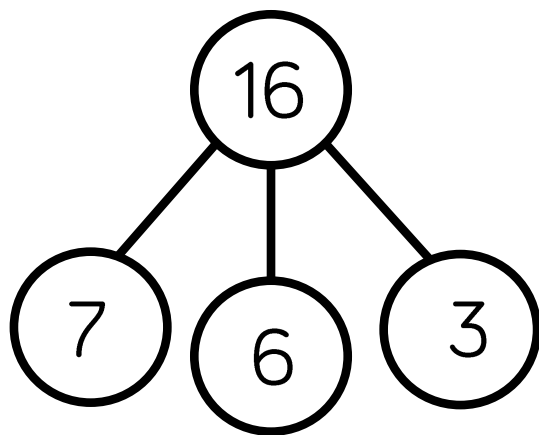

$$7 + 6 + 3 = 16$$

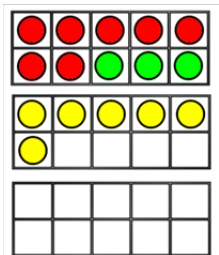
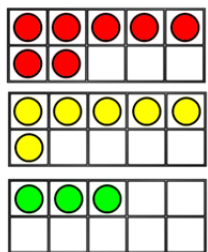

$$7 + 6 + 3 = 16$$

10

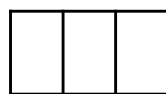

16

When adding three 1-digit numbers, children should be encouraged to look for number bonds to 10 or doubles to add the numbers more efficiently.

This supports children in their understanding of commutativity.

Manipulatives that highlight number bonds to 10 are effective when adding three 1-digit numbers.

Skill: Add 1-digit and 2-digit numbers to 100

Year: 2/3

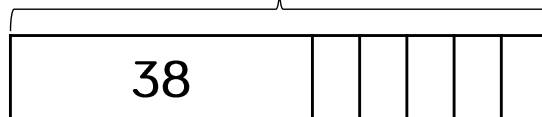
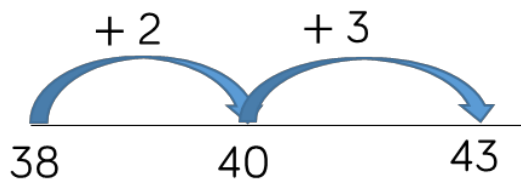
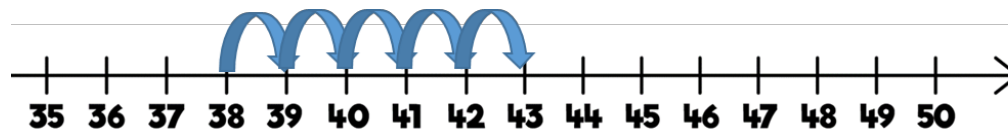
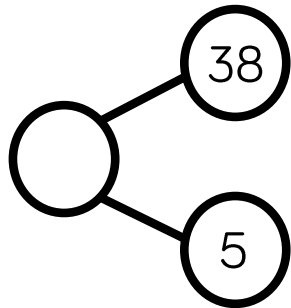

$$38 + 5 = 43$$

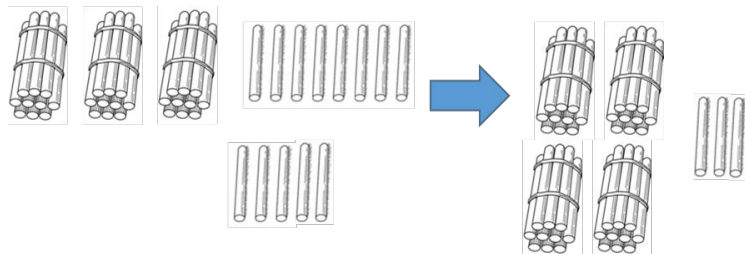

1	2	3	4	5	6	7	8	9	10
11	12	13	14	15	16	17	18	19	20
21	22	23	24	25	26	27	28	29	30
31	32	33	34	35	36	37	38	39	40
41	42	43	44	45	46	47	48	49	50
51	52	53	54	55	56	57	58	59	60
61	62	63	64	65	66	67	68	69	70
71	72	73	74	75	76	77	78	79	80
81	82	83	84	85	86	87	88	89	90
91	92	93	94	95	96	97	98	99	100

When adding single digits to a two-digit number, children should be encouraged to count on from the larger number.

They should also apply their knowledge of number bonds to add more efficiently e.g. $8 + 5 = 13$ so $38 + 5 = 43$.

Hundred squares and straws can support children to find the number bond to 10.

Skill: Add two 2-digit numbers to 100

Year: 2/3

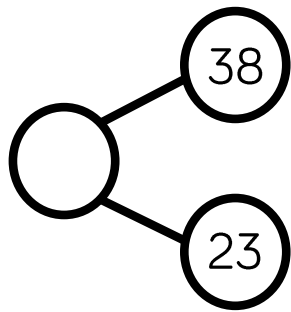

?

38	23
----	----

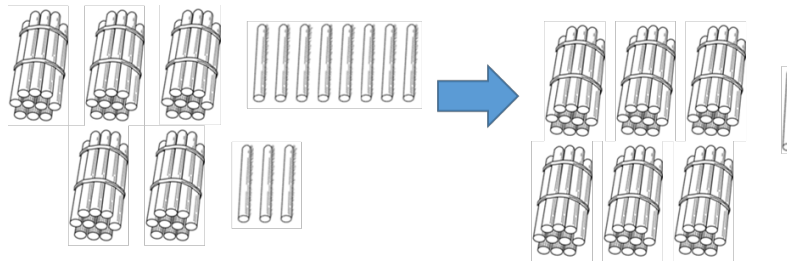
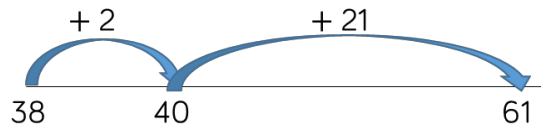

$$38 + 23 = 61$$

Tens	Ones

$$\begin{array}{r} 38 \\ + 23 \\ \hline 61 \\ 1 \end{array}$$

Tens	Ones

At this stage, encourage children to use the formal column method when calculating alongside straws, base 10 or place value counters. As numbers become larger, straws become less efficient.

Children can also use a blank number line to count on to find the total. Encourage them to jump to multiples of 10 to become more efficient.

Skill: Add numbers with up to 3 digits

Year: 3

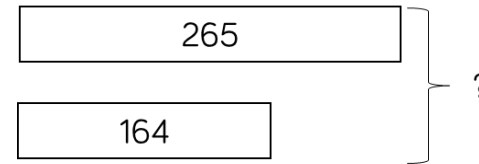
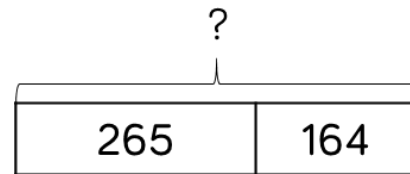
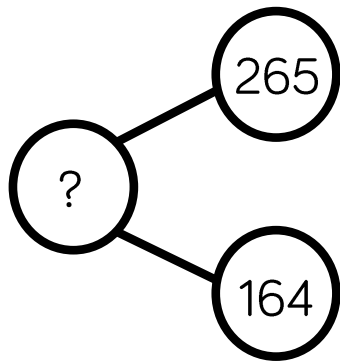

$$265 + 164 = 429$$

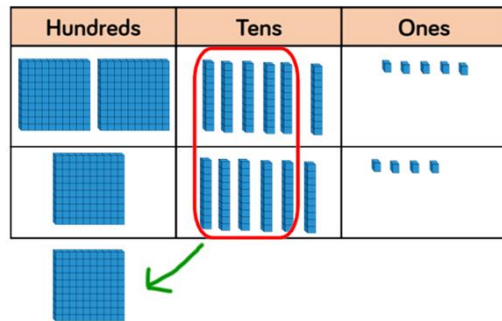

$$\begin{array}{r} 265 \\ + 164 \\ \hline 429 \\ \hline 1 \end{array}$$

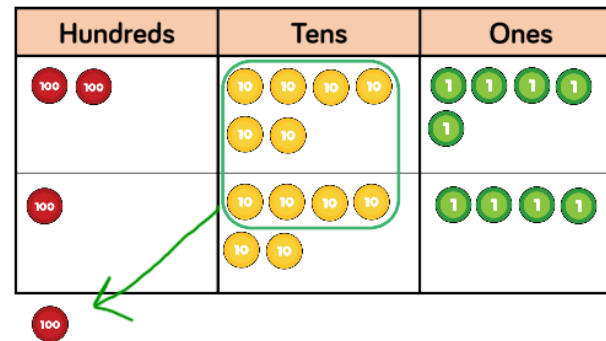

Base 10 and place value counters are the most effective manipulatives when adding numbers with up to 3 digits.

Ensure children write out their calculation alongside any concrete resources so they can see the links to the written column method.

Plain counters on a place value grid can also be used to support learning.

Skill: Add numbers with up to 4 digits

Year: 4

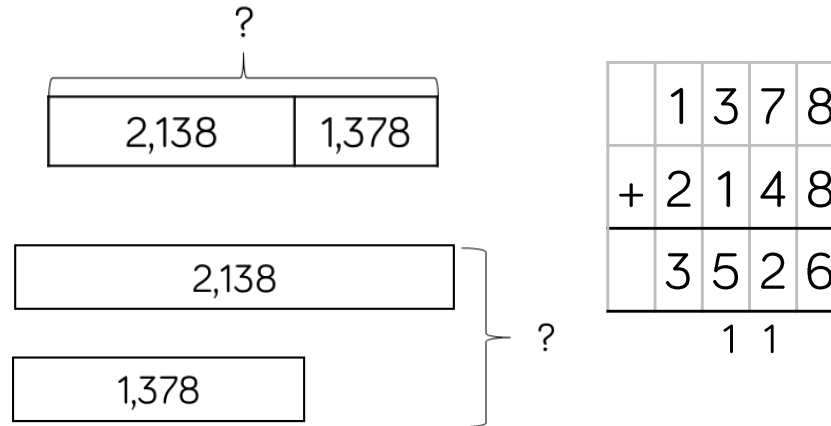
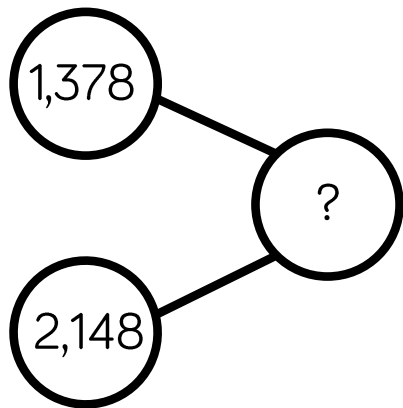

$$1,378 + 2,148 = 3,526$$

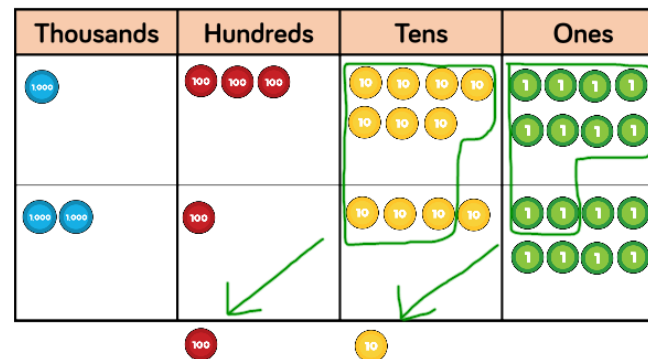
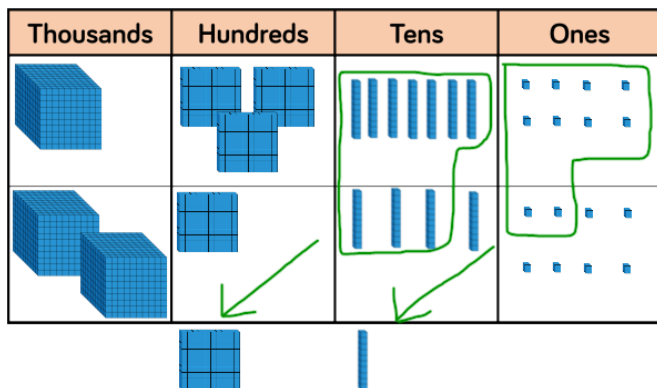

Base 10 and place value counters are the most effective manipulatives when adding numbers with up to 4 digits.

Ensure children write out their calculation alongside any concrete resources so they can see the links to the written column method.

Plain counters on a place value grid can also be used to support learning.

Skill: Add numbers with more than 4 digits

Year: 5/6

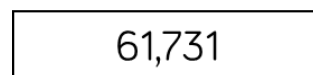
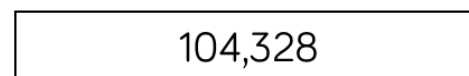
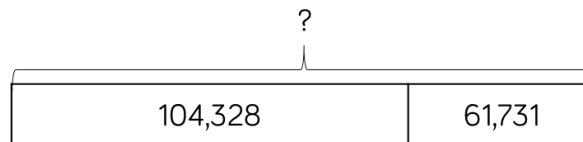
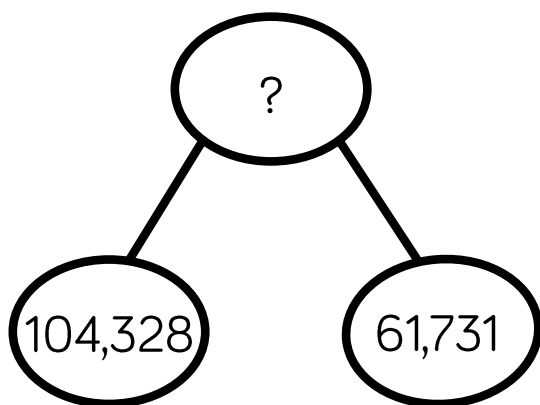

?

$$104,328 + 61,731 = 166,059$$

HTh	TTh	Th	H	T	O
100000		1000 1000 1000 1000	100 100 100	10 10	1 1 1 1 1 1 1 1
	10000 10000 10000 10000 10000 10000	1000	100 100 100 100 100 100 100	10 10 10	1

1	0	4	3	2	8
+	6	1	7	3	1
1	6	6	0	5	9

1

Place value counters or plain counters on a place value grid are the most effective concrete resources when adding numbers with more than 4 digits.

At this stage, children should be encouraged to work in the abstract, using the column method to add larger numbers efficiently.

Skill: Add with up to 3 decimal places

Year: 5

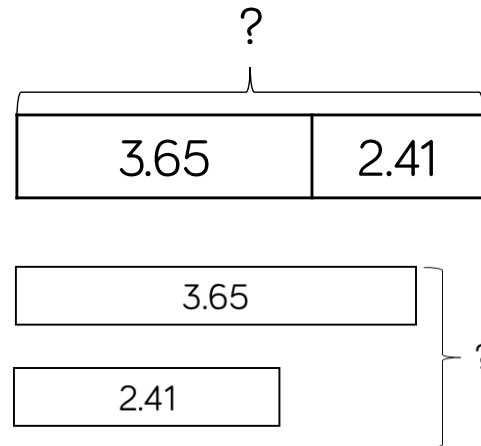
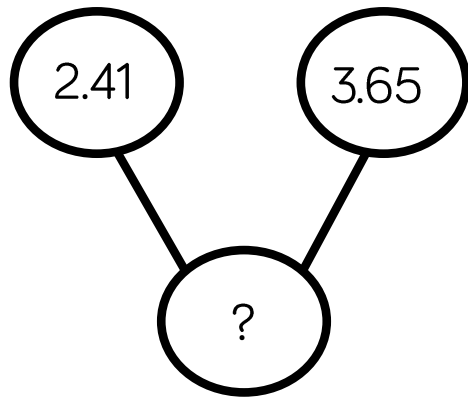

$$\begin{array}{r} 3.65 \\ + 2.41 \\ \hline 6.06 \\ 1 \end{array}$$

$$3.65 + 2.41 = 6.06$$

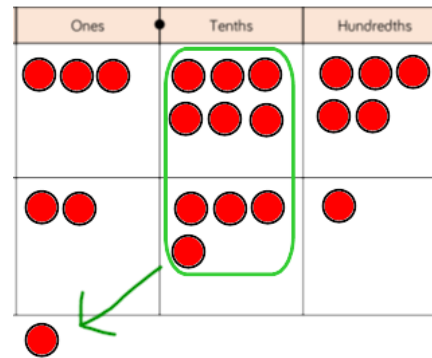
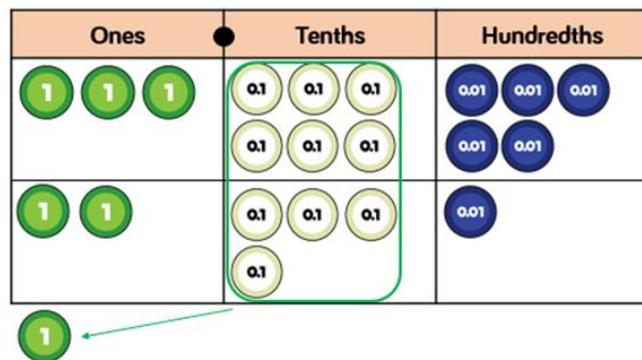

Place value counters and plain counters on a place value grid are the most effective manipulatives when adding decimals with 1, 2 and then 3 decimal places.

Ensure children have experience of adding decimals with a variety of decimal places. This includes putting this into context when adding money and other measures.

Subtraction

Skill	Year	Representations and models	
Subtract two 1-digit numbers to 10	1	Part-whole model Bar model Number shapes	Ten frames (within 10) Bead strings (10) Number tracks
Subtract 1 and 2-digit numbers to 20	1	Part-whole model Bar model Number shapes Ten frames (within 20)	Bead string (20) Number tracks Number lines (labelled) Straws
Subtract 1 and 2-digit numbers to 100	2	Part-whole model Bar model Number lines (labelled)	Number lines (blank) Straws Hundred square
Subtract two 2-digit numbers	2	Part-whole model Bar model Number lines (blank) Straws	Base 10 Place value counters Column addition

Skill	Year	Representations and models	
Subtract with up to 3-digits	3	Part-whole model Bar model	Base 10 Place value counters Column addition
Subtract with up to 4-digits	4	Part-whole model Bar model	Base 10 Place value counters Column addition
Subtract with more than 4 digits	5	Part-whole model Bar model	Place value counters Column addition
Subtract with up to 3 decimal places	5	Part-whole model Bar model	Place value counters Column addition

Skill: Subtract 1-digit numbers within 10

Year: 1

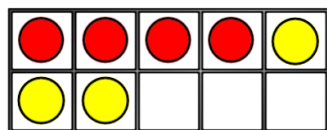
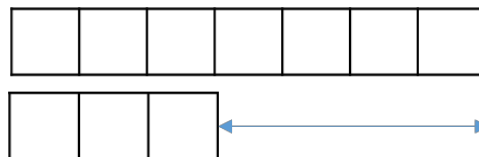
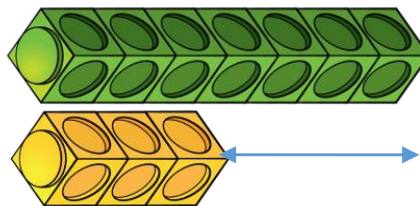
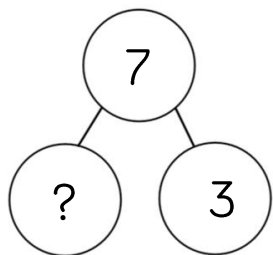

$$7 - 3 = 4$$

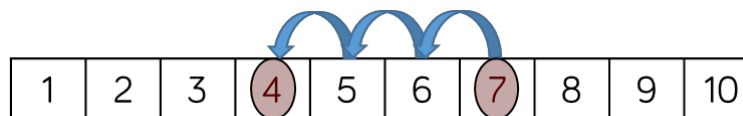
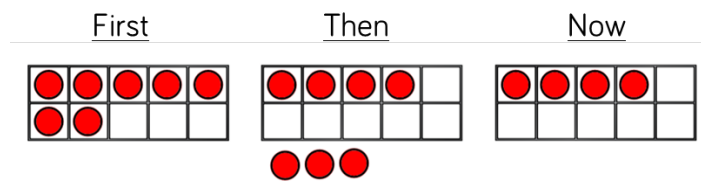
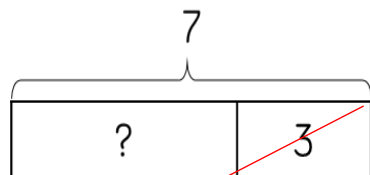
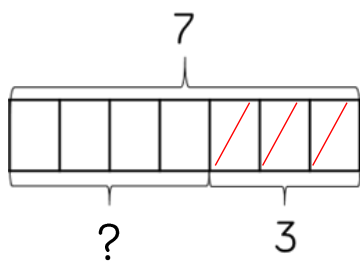

Part-whole models, bar models, ten frames and number shapes support partitioning.

Ten frames, number tracks, single bar models and bead strings support reduction.

Cubes and bar models with two bars can support finding the difference.

Skill: Subtract 1 and 2-digit numbers to 20

Year: 1/2

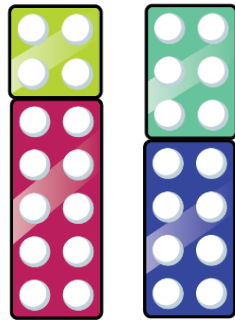
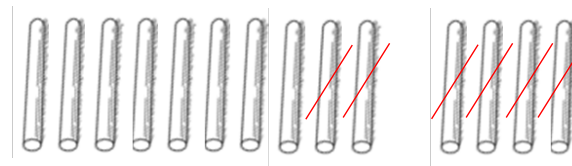
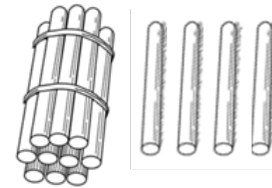
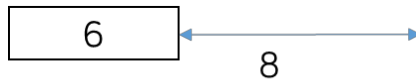
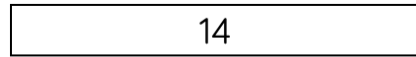
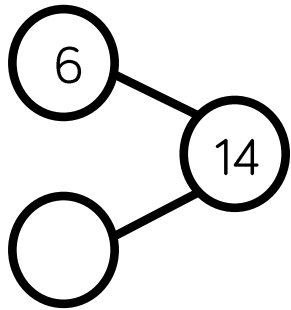

$$14 - 6 = 8$$

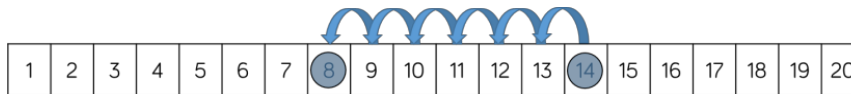

$$14 - 6 = 8$$

A number bond diagram for $14 - 6 = 8$. The number 14 is circled. A line from 14 goes to 4, and another line goes to 2. The number 6 is written below the line to 2.

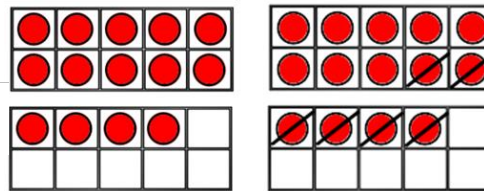
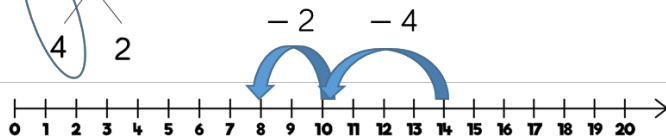

$$14 - 6 = 8$$

A number bond diagram for $14 - 6 = 8$. The number 14 is circled. A line from 14 goes to 4, and another line goes to 2. The number 6 is written below the line to 2.

When subtracting one-digit numbers that cross 10, it is important to highlight the importance of ten ones equalling one ten.

Children should be encouraged to find the number bond to 10 when partitioning the subtracted number. Ten frames, number shapes and number lines are particularly useful for this.

Skill: Subtract 1 and 2-digit numbers to 100

Year: 2

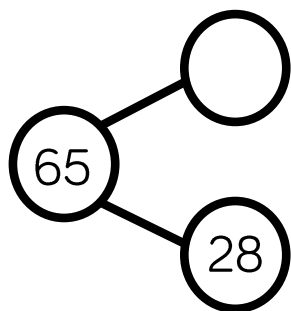

65

?	28
---	----

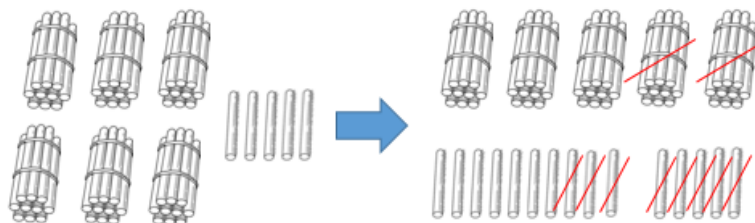
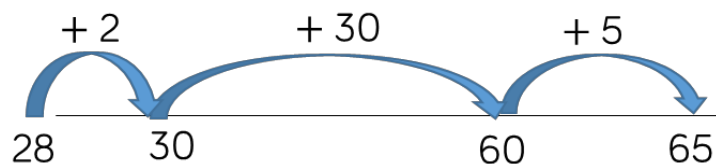

$$65 - 28 = 37$$

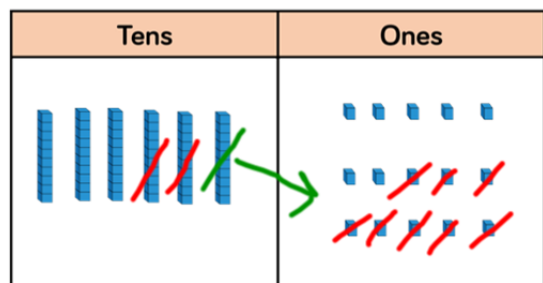

$$\begin{array}{r} 5 \quad 1 \\ 65 \\ - 28 \\ \hline 37 \end{array}$$

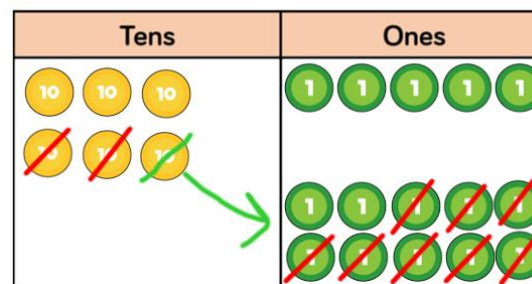

At this stage, encourage children to use the formal column method when calculating alongside straws, base 10 or place value counters. As numbers become larger, straws become less efficient.

Children can also use a blank number line to count on to find the difference. Encourage them to jump to multiples of 10 to become more efficient.

Skill: Subtract numbers with up to 3 digits

Year: 3

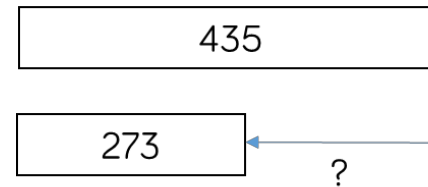
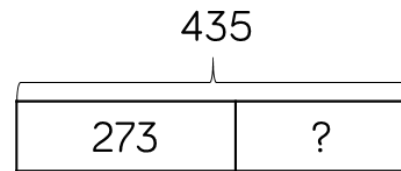
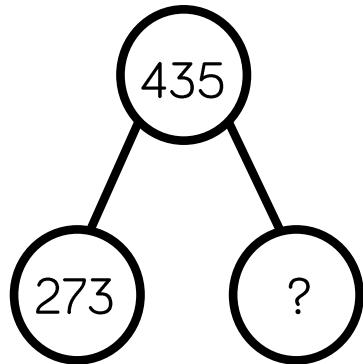

$$435 - 273 = 262$$

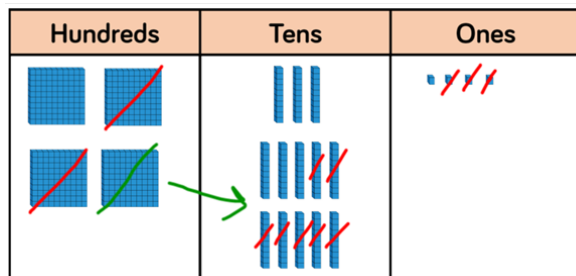

$$\begin{array}{r} 3 \\ 435 \\ - 273 \\ \hline 262 \end{array}$$

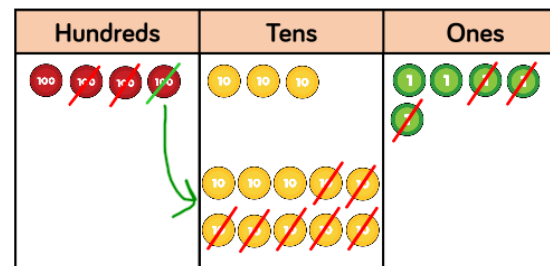

Base 10 and place value counters are the most effective manipulative when subtracting numbers with up to 3 digits.

Ensure children write out their calculation alongside any concrete resources so they can see the links to the written column method.

Plain counters on a place value grid can also be used to support learning.

Skill: Subtract numbers with up to 4 digits

Year: 4

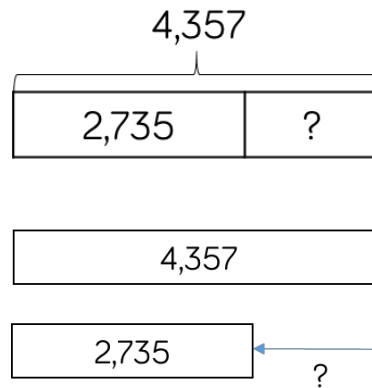
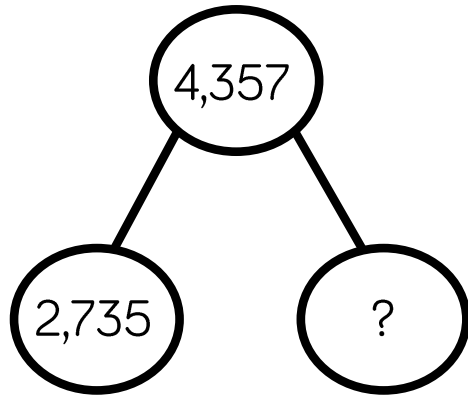

$$\begin{array}{r} 3 \ 1 \\ \cancel{4}357 \\ - 2735 \\ \hline 1622 \end{array}$$

$$4,357 - 2,735 = 1,622$$

Thousands	Hundreds	Tens	Ones

Thousands	Hundreds	Tens	Ones

Base 10 and place value counters are the most effective manipulatives when subtracting numbers with up to 4 digits.

Ensure children write out their calculation alongside any concrete resources so they can see the links to the written column method.

Plain counters on a place value grid can also be used to support learning.

Skill: Subtract numbers with more than 4 digits

Year: 5/6

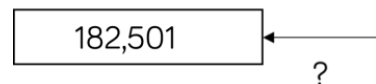
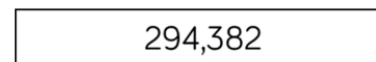
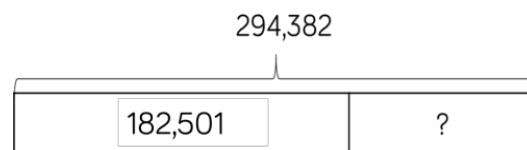
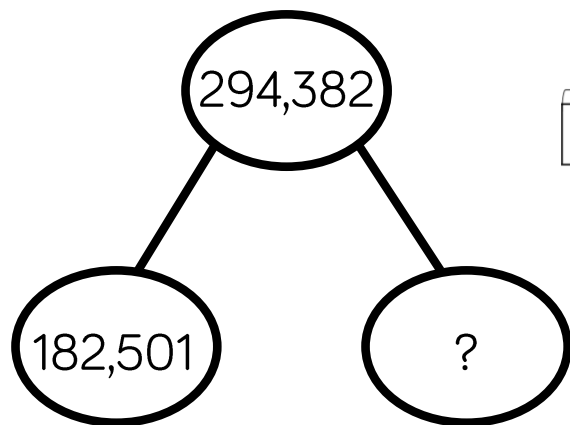

$$294,382 - 182,501 = 111,881$$

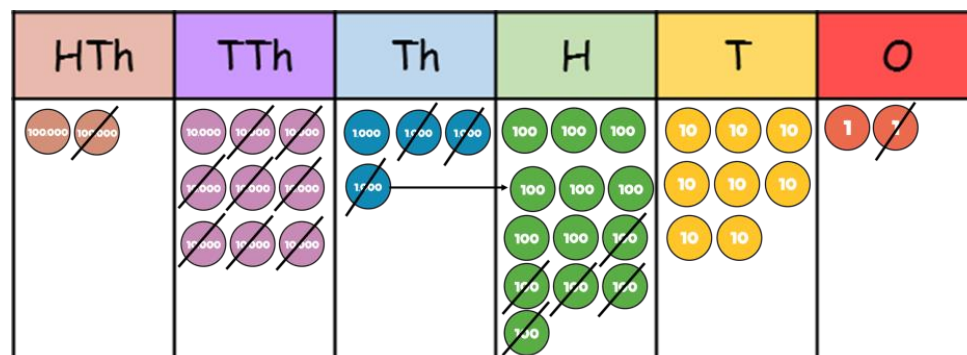

	2	9	3	13	8	2
-	1	8	2	5	0	1
	1	1	1	8	8	1

Place value counters or plain counters on a place value grid are the most effective concrete resource when subtracting numbers with more than 4 digits.

At this stage, children should be encouraged to work in the abstract, using column method to subtract larger numbers efficiently.

Skill: Subtract with up to 3 decimal places

Year: 5

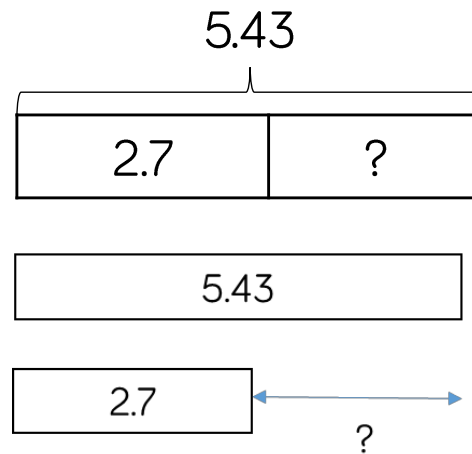
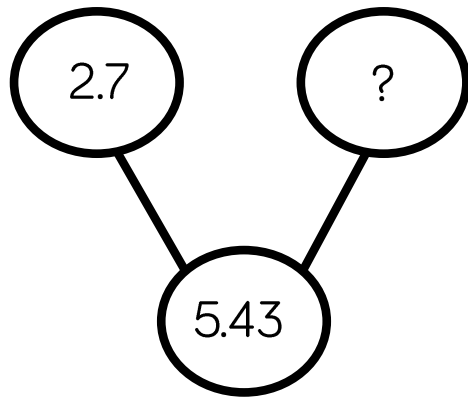

$$\begin{array}{r} 4 \quad 1 \\ 5.43 \\ - 2.7 \\ \hline 2.73 \end{array}$$

$$5.43 - 2.7 = 2.73$$

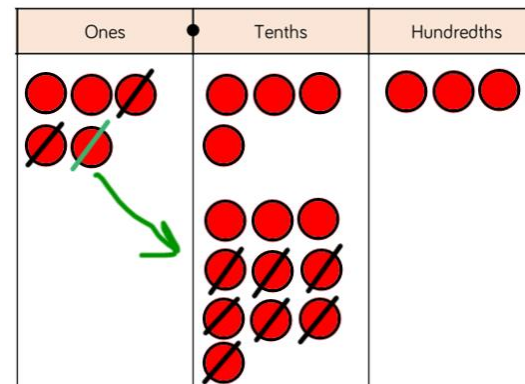
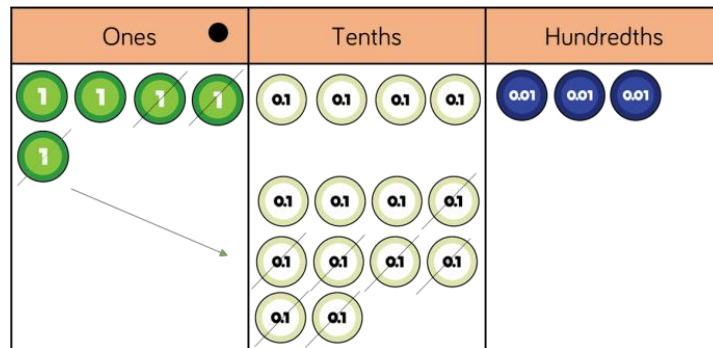

Place value counters and plain counters on a place value grid are the most effective manipulative when subtracting decimals with 1, 2 and then 3 decimal places.

Ensure children have experience of subtracting decimals with a variety of decimal places. This includes putting this into context when subtracting money and other measures.

Glossary

Addend - A number to be added to another.

Aggregation - combining two or more quantities or measures to find a total.

Augmentation - increasing a quantity or measure by another quantity.

Commutative - numbers can be added in any order.

Complement - in addition, a number and its complement make a total e.g. 300 is the complement to 700 to make 1,000

Difference - the numerical difference between two numbers is found by comparing the quantity in each group.

Exchange - Change a number or expression for another of an equal value.

Minuend - A quantity or number from which another is subtracted.

Partitioning - Splitting a number into its component parts.

Reduction - Subtraction as take away.

Subitise - Instantly recognise the number of objects in a small group without needing to count.

Subtrahend - A number to be subtracted from another.

Sum - The result of an addition.

Total - The aggregate or the sum found by addition.